

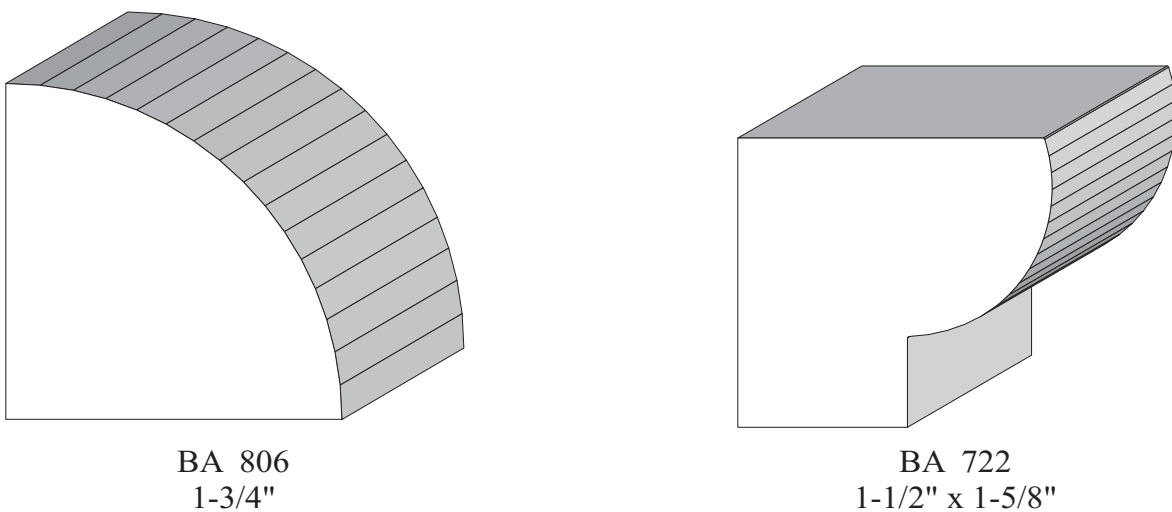

Rounds: Quarter,
Half & Full

NOTE:
All rounds can be configured as
full, half, quarter & bull nose.

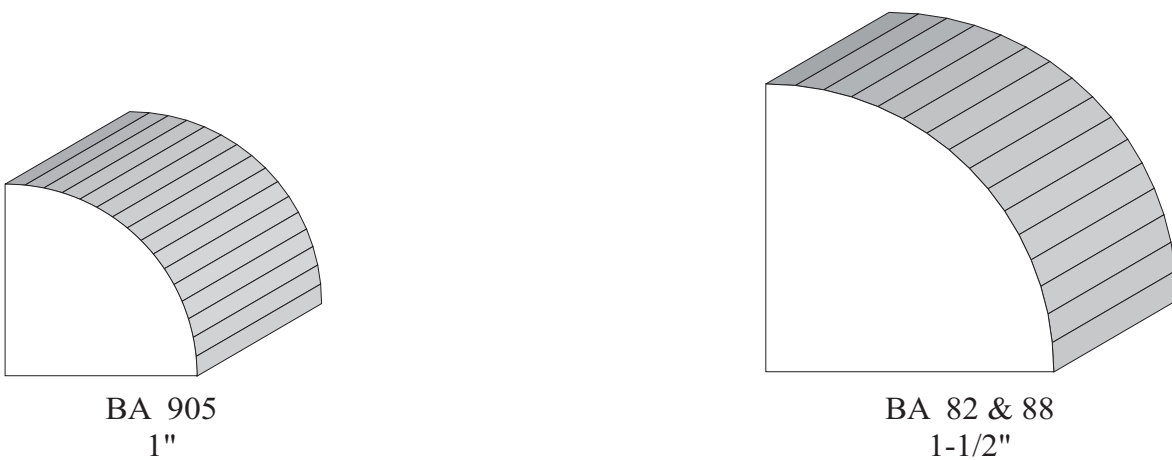
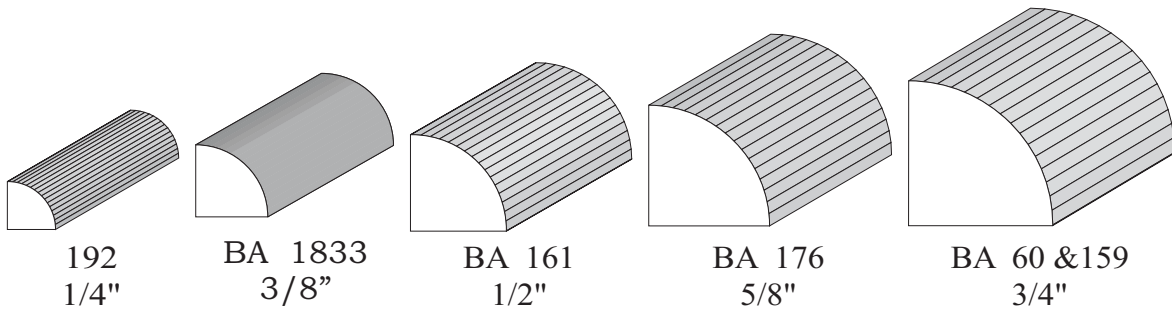

Profile dimensions can be adjusted, please call for details.



Rounds: Quarter,
Half & Full

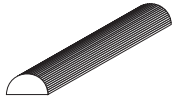

BA 704
7/32"



BA 463
1/4" x 1-5/8"

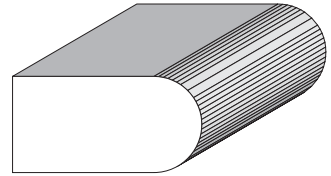

BA 1077
1/2" x 1"

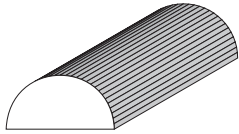

BA 803
9/16"

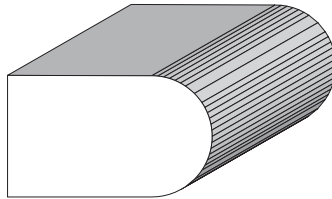

BA 494
5/8"

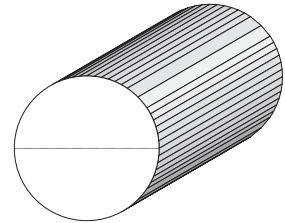

BA 352, 612 & 223
3/4"

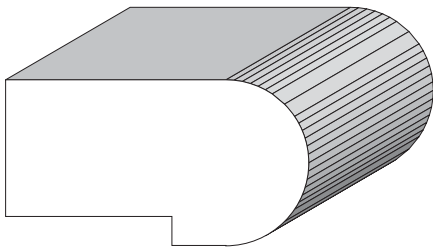

BA 739
7/8" x 1-9/16"

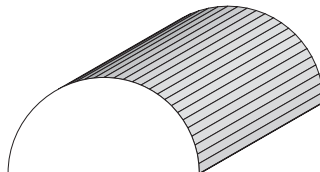

BA 115 & 319
1"

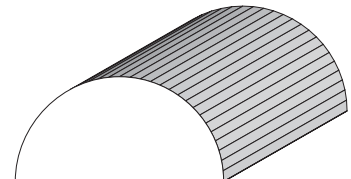

BA 133A & 342
1-1/8"

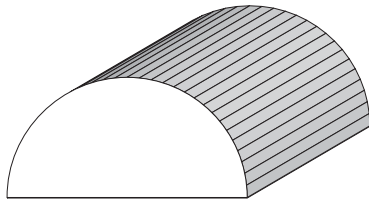

BA 59
1-1/4"

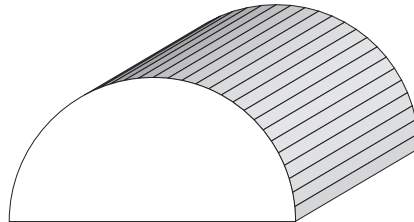

BA 200 & 347
1-1/2"

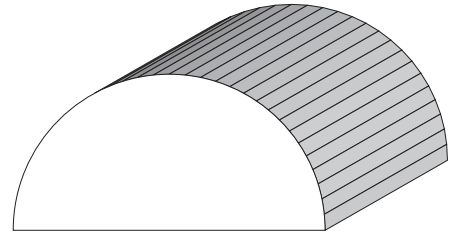

BA 340B
1-5/8"

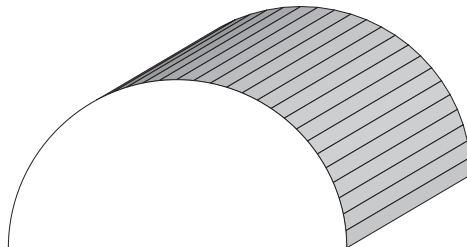

BA 283
1-3/4"

Profile dimensions can be adjusted, please call for details.



Rounds: Quarter,
Half & Full

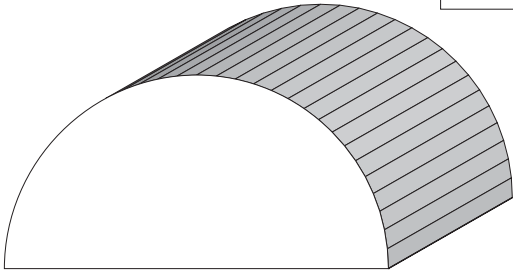

BA 129 & 210
2"

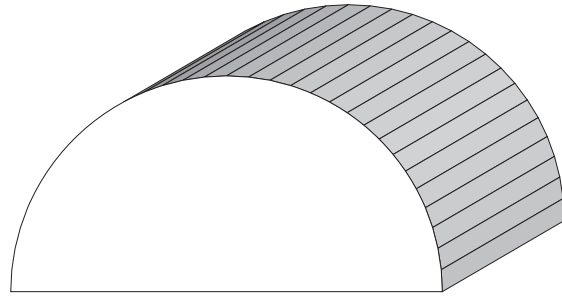

BA 536
2-1/4"

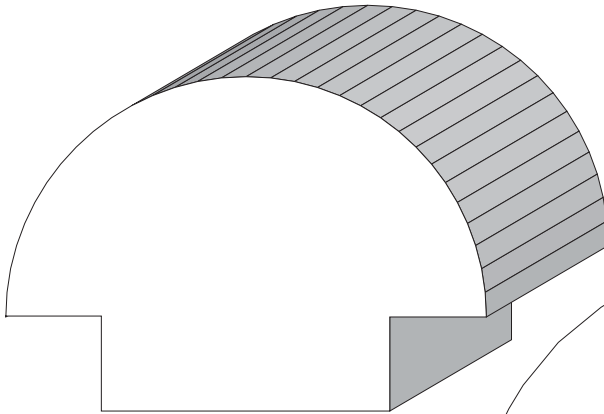

BA 620
1-3/4" x 2-1/2"

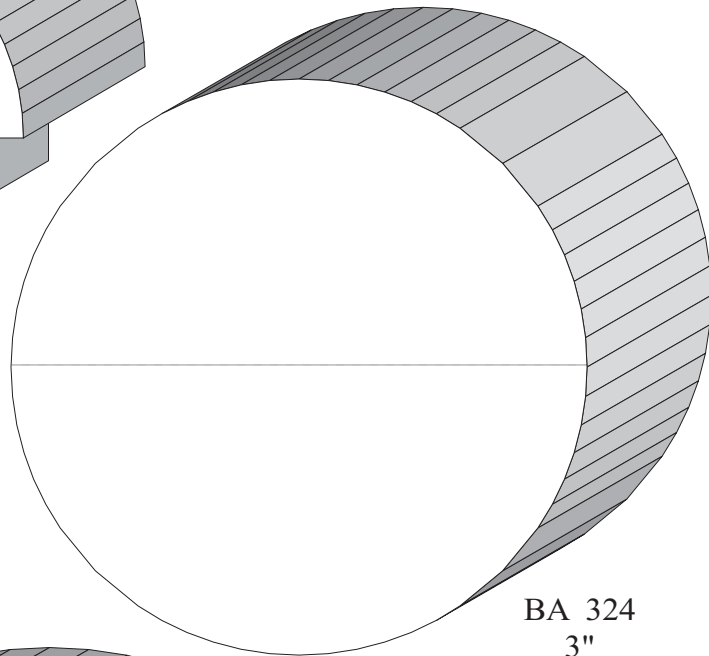

BA 324
3"

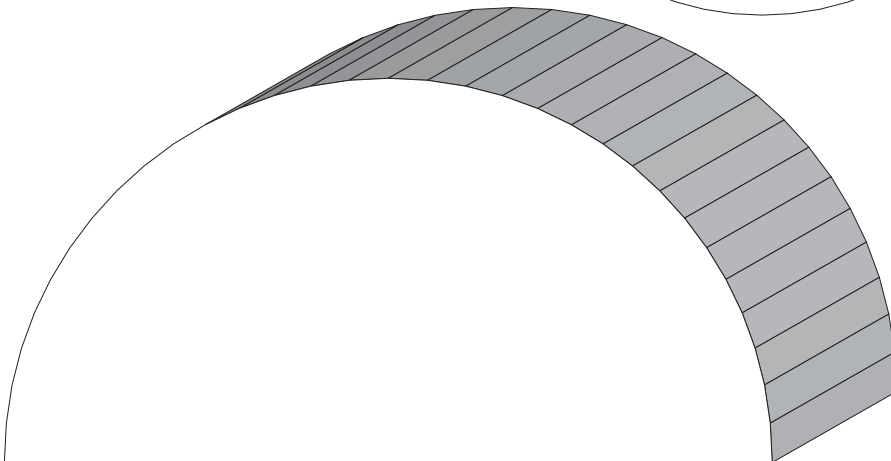

BA 359
4"

Profile dimensions can be adjusted, please call for details.



Rounds: Quarter,
Half & Full

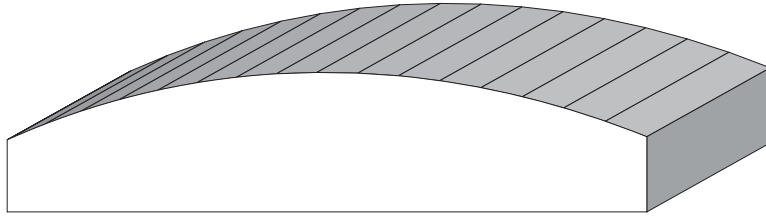

BA 688
4-5/16" Radius
3-5/16" Chord

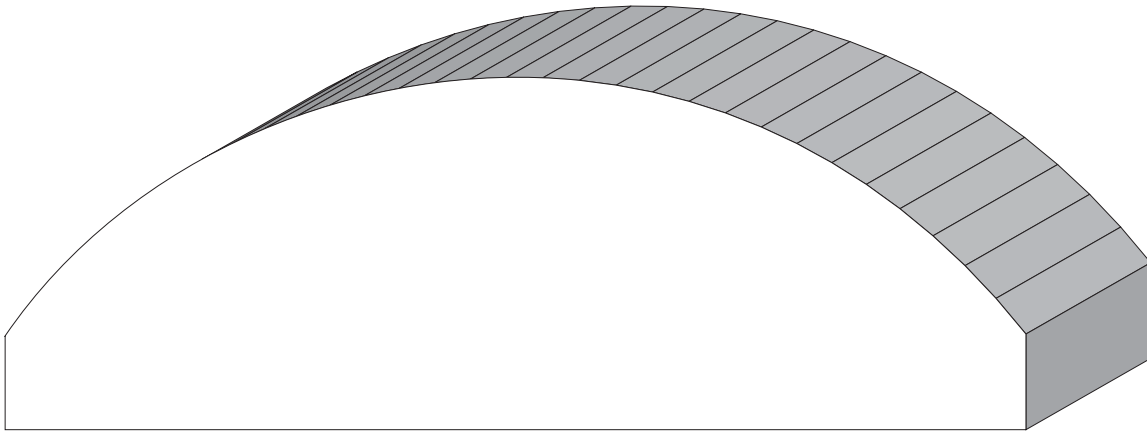

BA 700
3-5/16" Radius
5-5/16" Chord

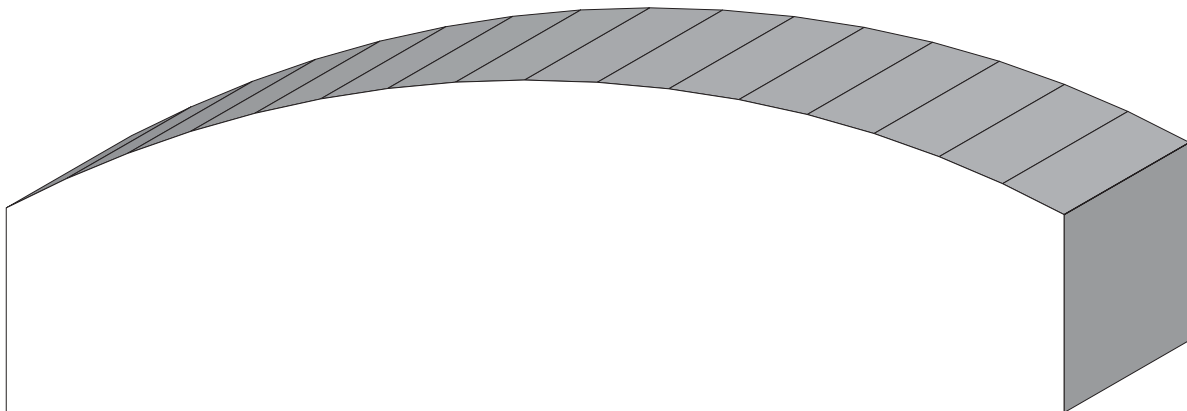

BA 979
6" Radius
5-1/2" Chord

Profile dimensions can be adjusted, please call for details.



Rounds: Quarter,
Half & Full

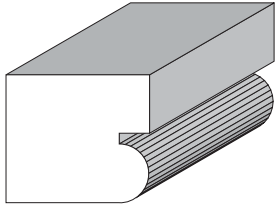

BA 736
3/4" x 11/16"

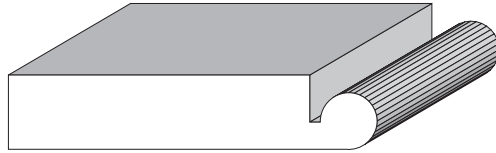

BA 15
3/8" x 1-15/16"

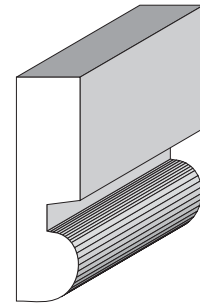

BA 357
3/8" bead for exterior
siding.



BA 17
7/16" x 2-1/2"

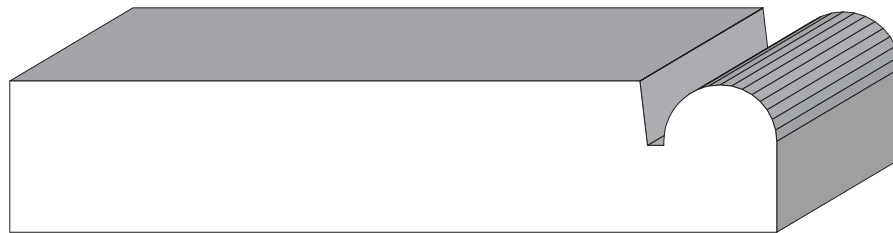

BA 530
3/4" x 4"

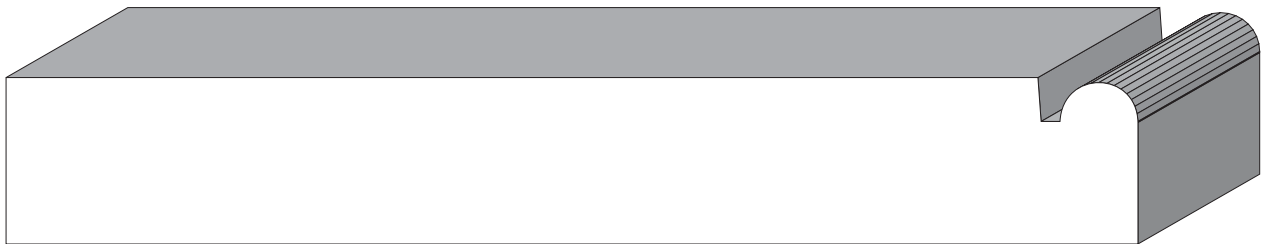

BA 741
7/8" x 5-7/8"

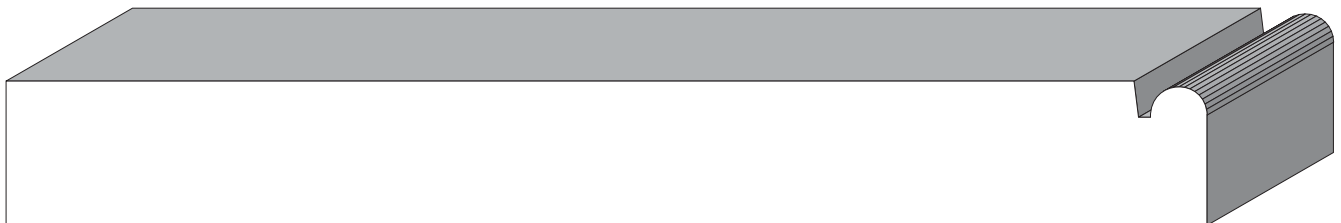

BA 769
3/4" x 6-5/16"

Profile dimensions can be adjusted, please call for details.



Rounds: Quarter,
Half & Full

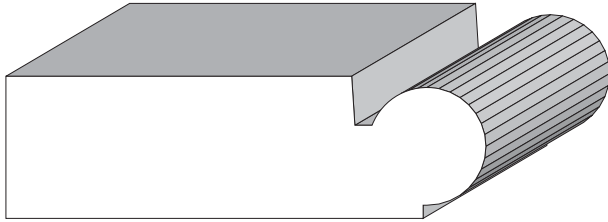

BA 570
3/4" x 2-1/2"

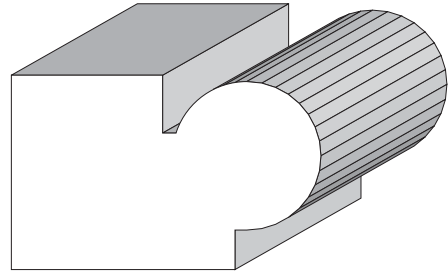

BA 637
1" x 1-5/8"

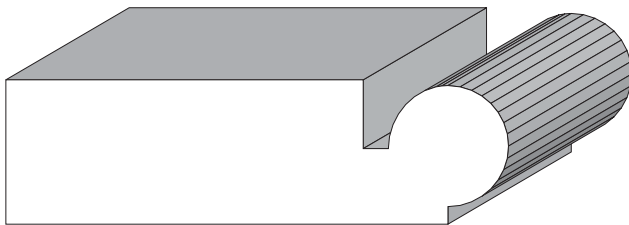

BA 998 & BA 494
3/4" x 2-5/8"

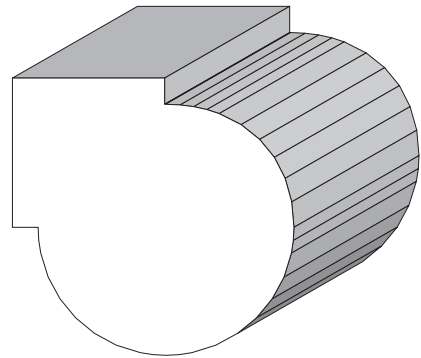

BA 781A
1-7/16" x 1-7/16"

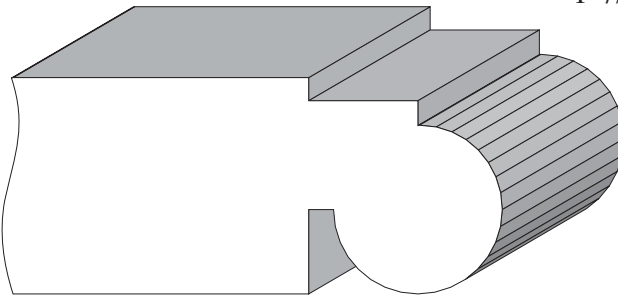

BA 708
1-1/8" x 2-5/8"

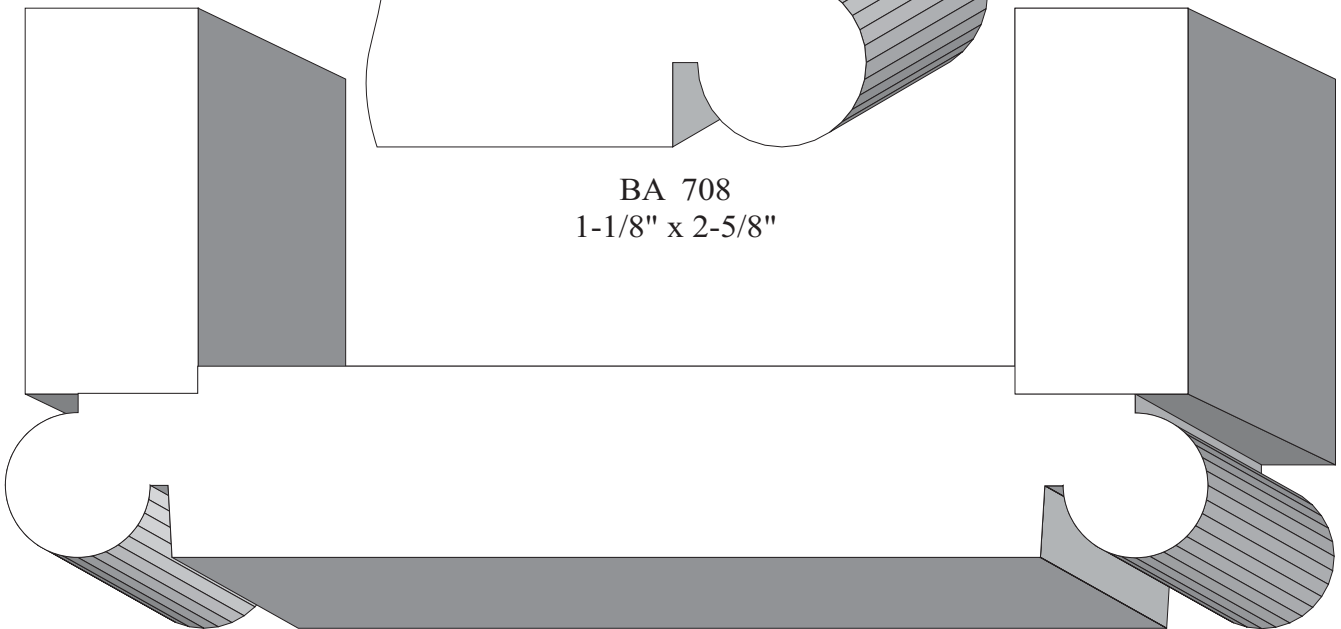

BA 648
1" x 6-1/4"

Profile dimensions can be adjusted, please call for details.



Rounds: Quarter,
Half & Full

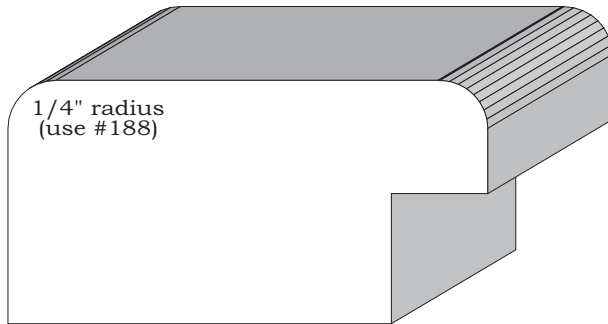

BA 364
1-1/4" x 2-1/2"

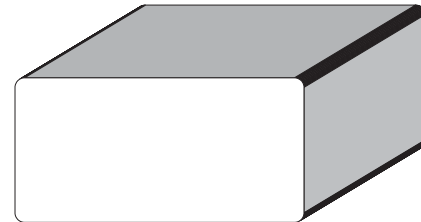

BA 643
3/4" x 1-1/2"

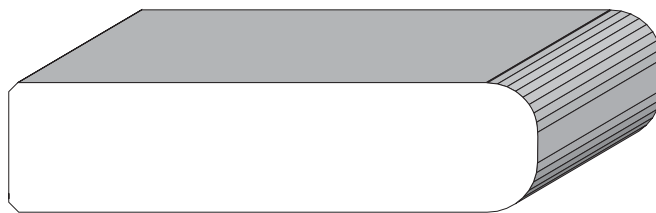

BA 239
11/16" x 2-3/4"

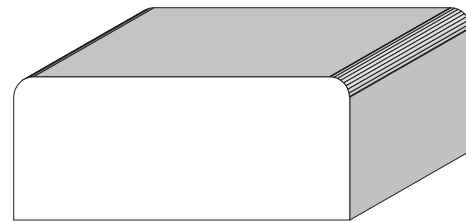

327
3/4" x 1-3/4"

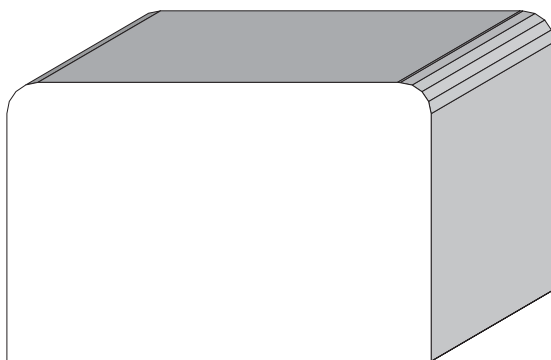

BA 365
1-7/16" x 2-1/4"

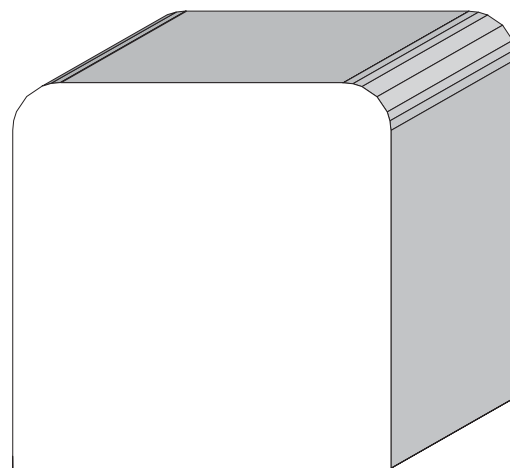

BA 402
2" x 2"

Profile dimensions can be adjusted, please call for details.



Rounds: Quarter,
Half & Full

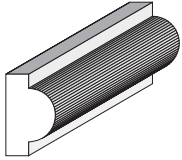

BA 560
1/4" x 7/16"

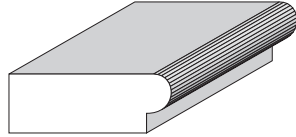

BA 229
5/16" x 13/16"

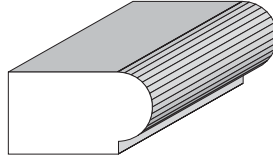

BA 280
7/16" x 3/4"

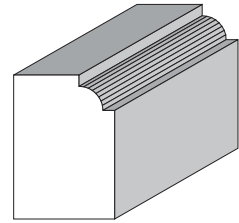

BA 1258
3/4"

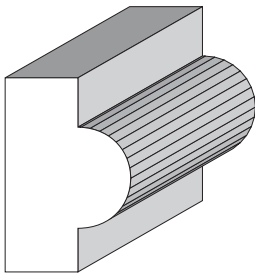

BA 56
5/8" x 1"

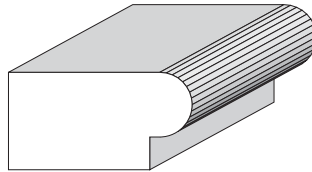

BA 11
1/2" x 15/16"

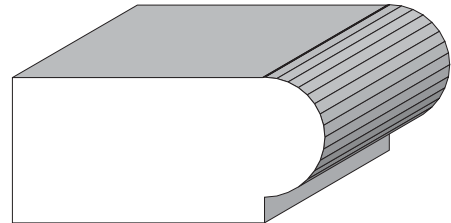

BA 550
3/4" x 1-5/8"

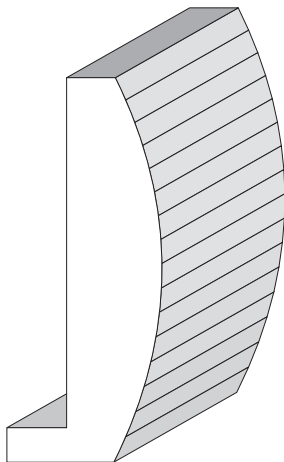

BA 1140
13/16" x 2"

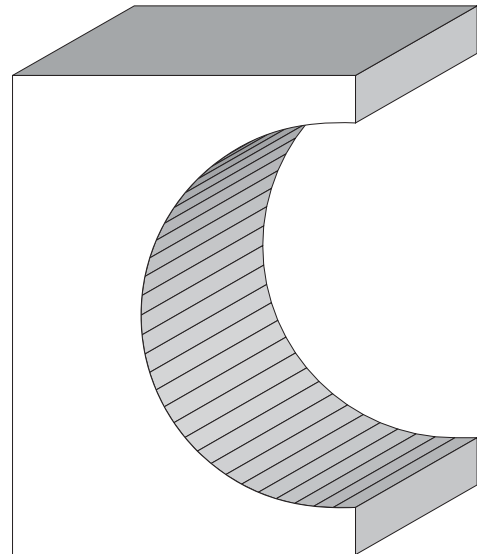

BA 889
1-13/16" x 2-1/2"

Profile dimensions can be adjusted, please call for details.



Rounds: Quarter,
Half & Full

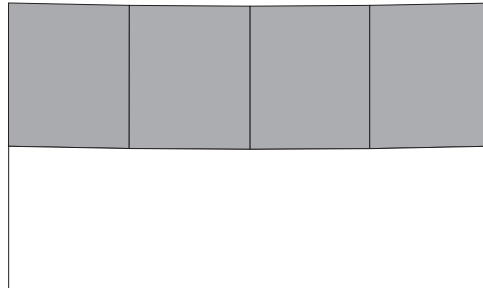

BA 1027
48" Radius
2-1/2" Chord

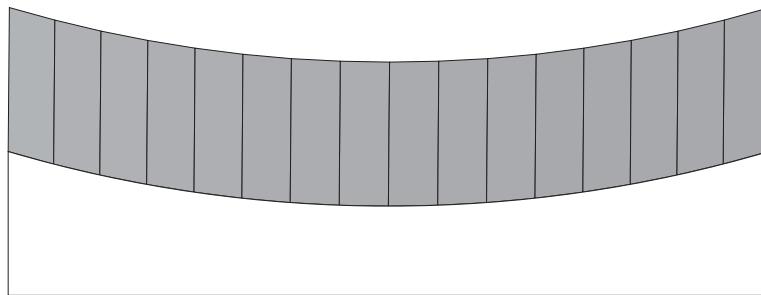

BA 1322
7" Radius
3-15/16" Chord

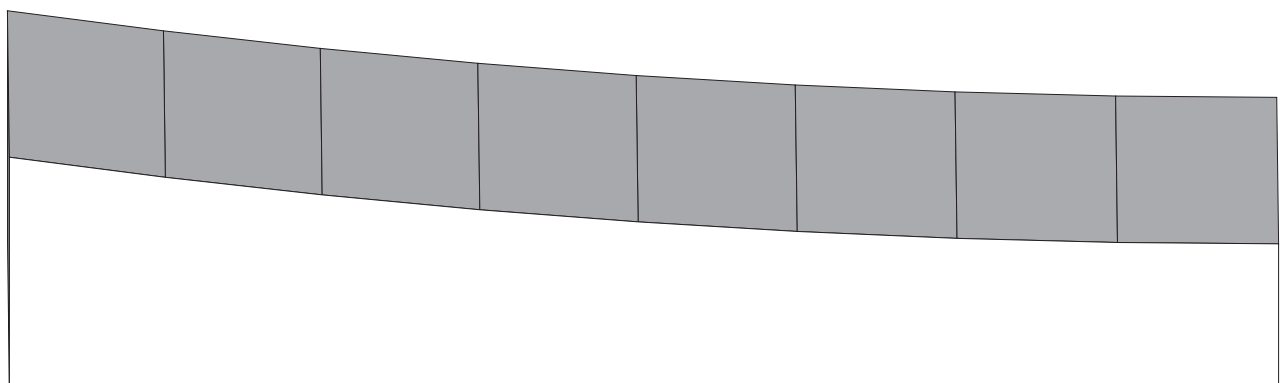

BA 1028
48" Radius
6-5/8" Chord

Profile dimensions can be adjusted, please call for details.



Rounds: Quarter,
Half & Full

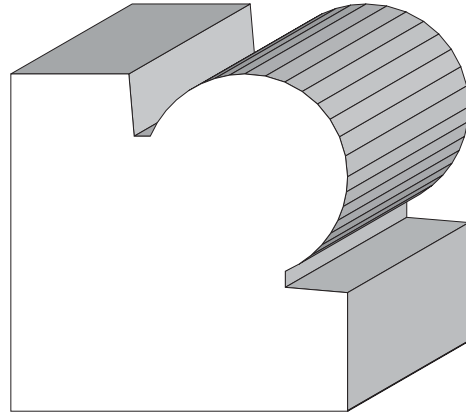

BA 1284
2-1/2" x 2-1/2"

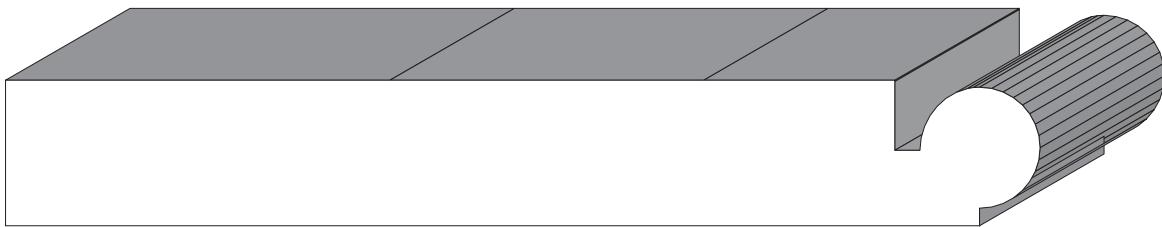

BA 1131 & 494
3/4" x 5-5/16"

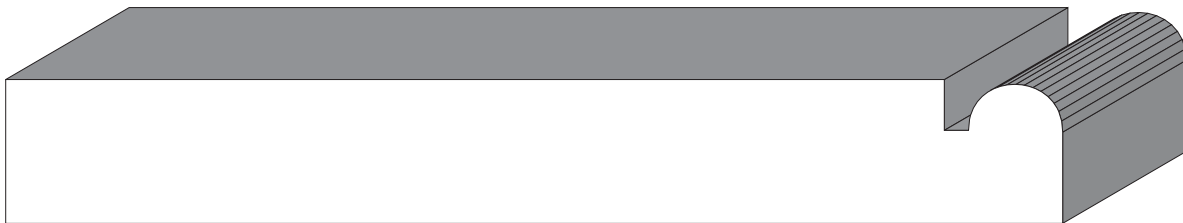

BA 1182
3/4" x 5-1/2"

Profile dimensions can be adjusted, please call for details.



Rounds: Quarter,
Half & Full

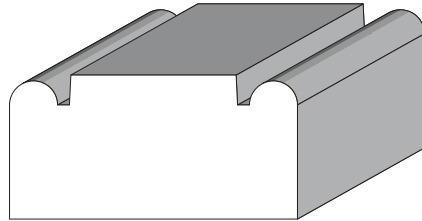

BA 1514
3/4" x 1-1/2"

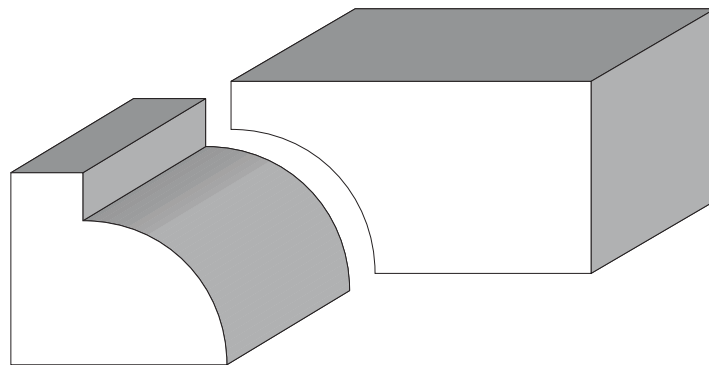

BA 1542A & B
1"

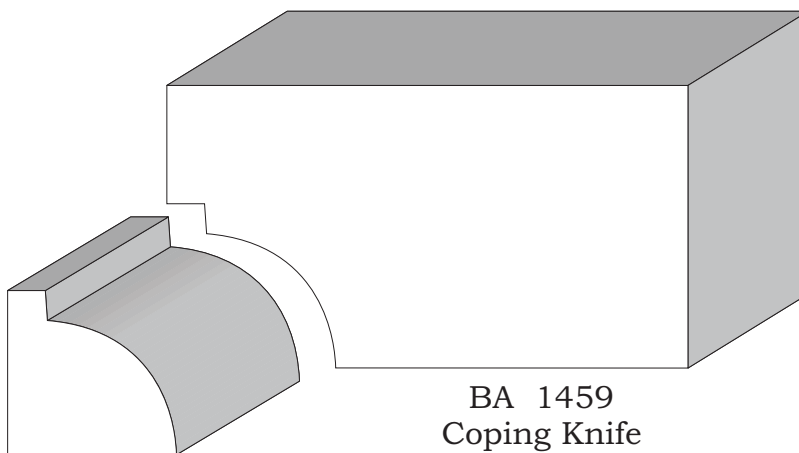

BA 1458
7/8" x 7/8"

BA 1459
Coping Knife
for BA 1458

Profile dimensions can be adjusted, please call for details.



Rounds: Quarter,
Half & Full

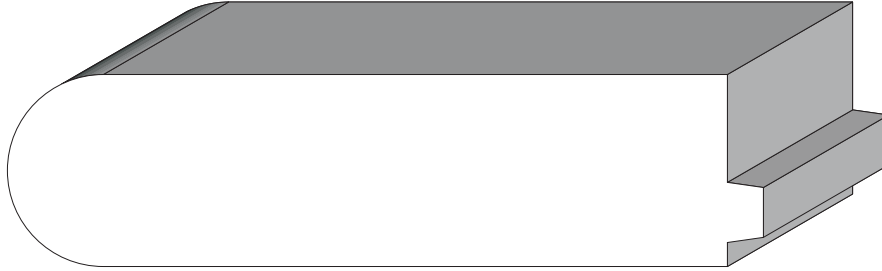

BA 1673
1" x 3-15/16"



BA 1495
3/4" x 4-1/2"

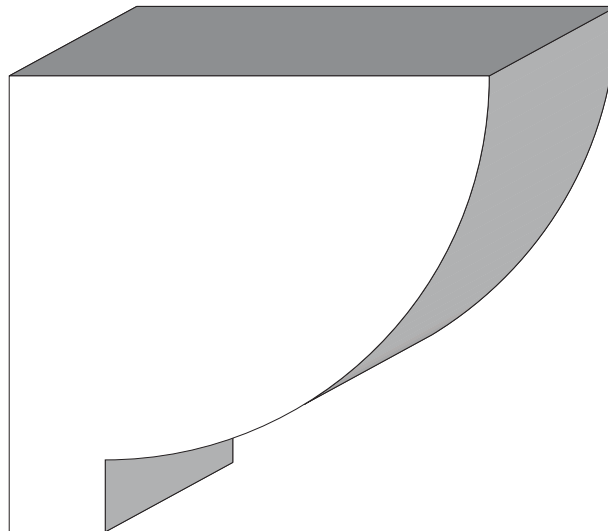

BA 1526
2-3/8" x 2-1/2"

Profile dimensions can be adjusted, please call for details.



Rounds: Quarter,
Half & Full

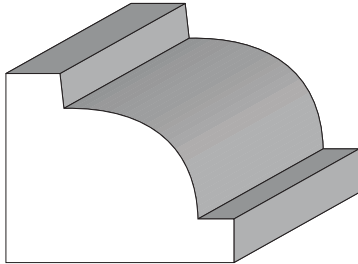

BA 1629
1" x 1-3/16"

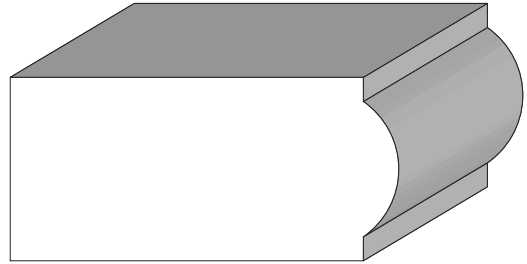

BA 1616
1" x 2"

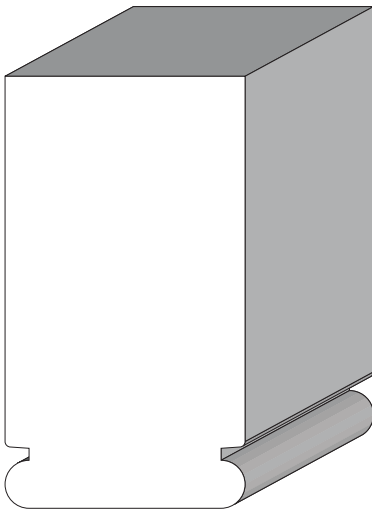

BA 1622
1-1/4" X 2-1/4"

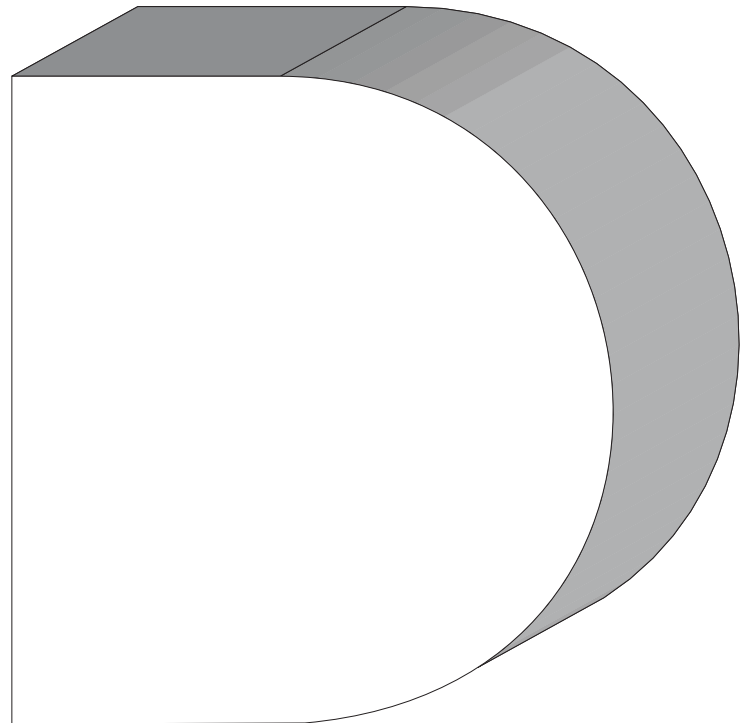

BA 1516
3-3/8"

Profile dimensions can be adjusted, please call for details.



Rounds: Quarter,
Half & Full

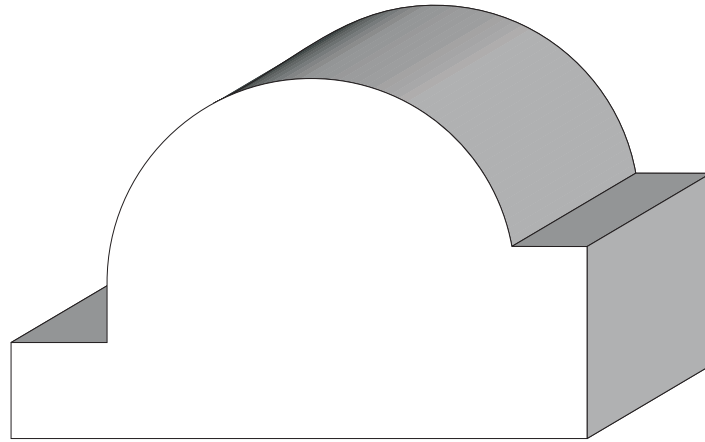

BA 1556
1-7/8" x 3"

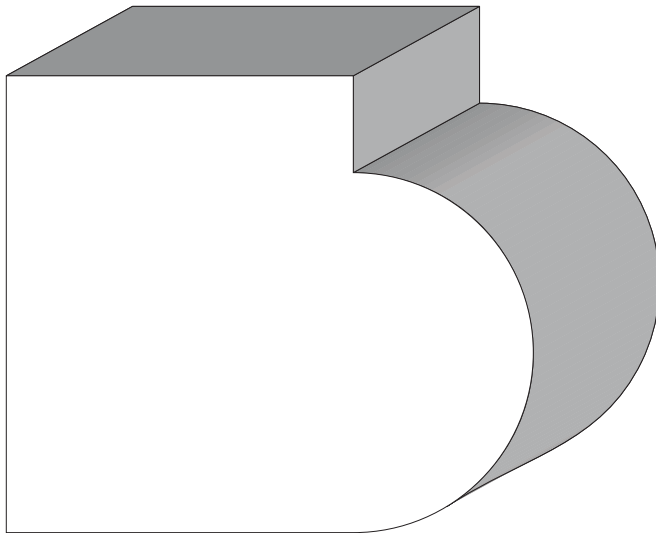

BA 1555
2-3/8" x 2-3/4"

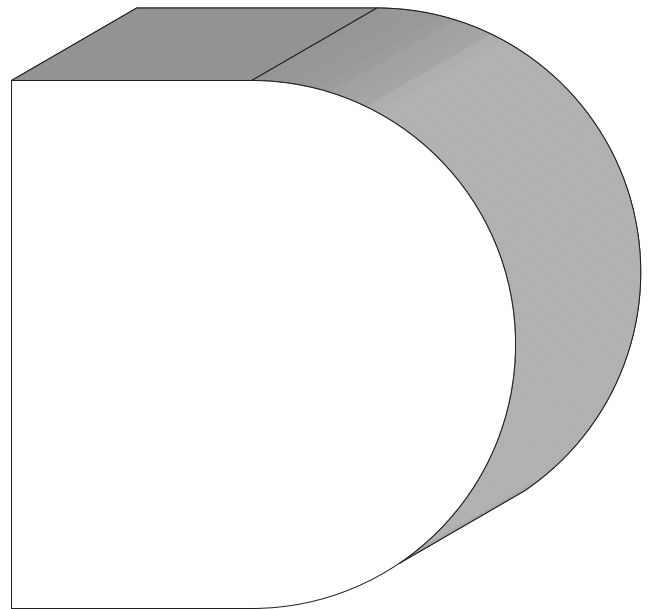

BA 1819
2-3/4" x 2-5/8"

Profile dimensions can be adjusted, please call for details.



Rounds: Quarter
Half & Full

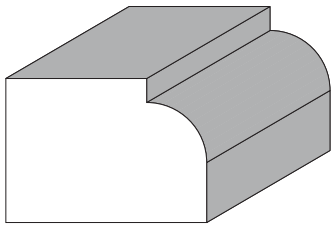

BA 1842
5/8" Diameter

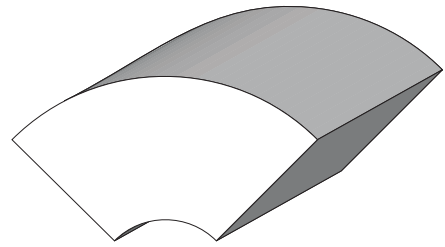

BA 1844
7/8" x 1-5/8"

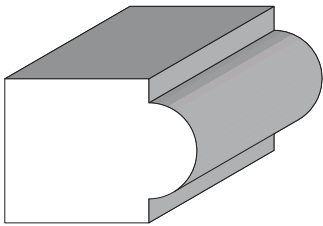

BA 1785
3/4"

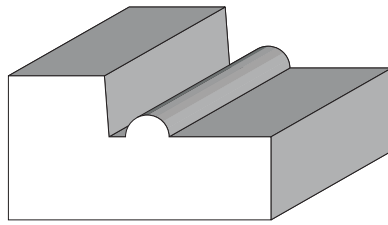

BA 1657
3/4" x 1-3/8"

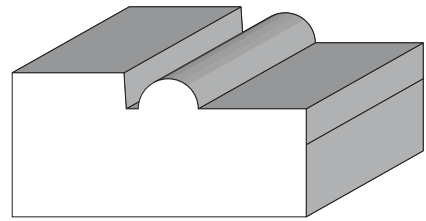

BA 1649
3/4" x 1-1/2"

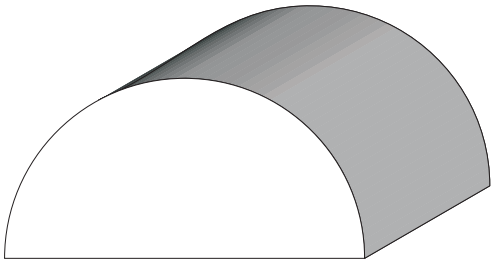

BA 1828
1-7/8"

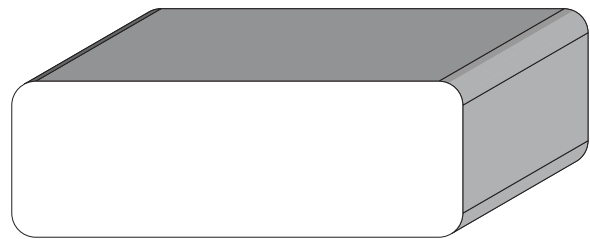

BA 1747A & B
13/16" x Different Widths

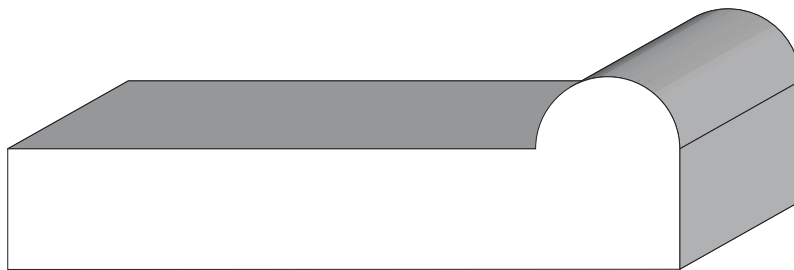

BA 1647
1" x 3"

Profile dimensions can be adjusted, please call for details.

