

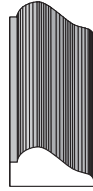

Panel Molds



BA 702
5/16" x 7/16"



BA 625
3/16" X 7/16"

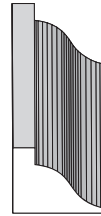

BA 354
3/8" x 1/2"

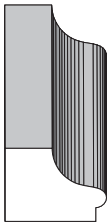

BA 819
3/8" x 1/2"

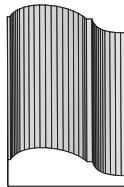

BA 592
1/4" x 5/8"

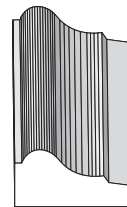

BA 1062
5/16" x 5/8"

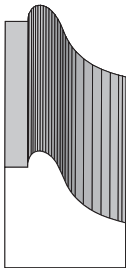

BA 820
5/8" x 5/8"

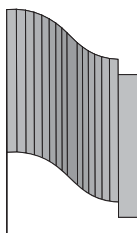

BA 882
7/16" x 11/16"

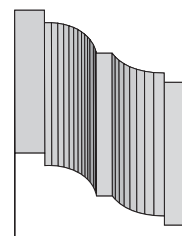

BA 418
7/16" x 15/16"

Profile dimensions can be adjusted, please call for details.



Panel Molds

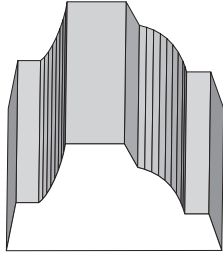

BA 1089
9/16" x 1-1/8"

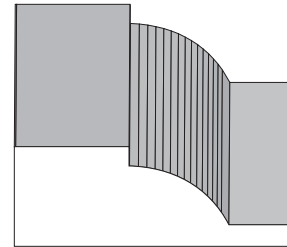

BA 194
1/2" x 1-7/16"

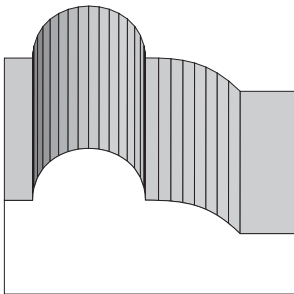

BA 1004
3/4" x 1-1/2"

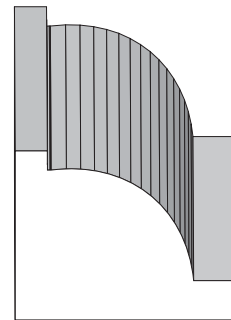

BA 126
7/8" x 1-1/8"

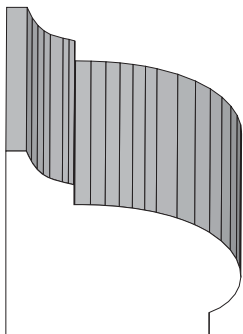

BA 96
15/16" x 1-3/16"

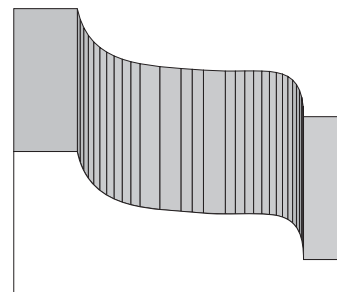

BA 836
3/4" x 1-3/4"

Profile dimensions can be adjusted, please call for details.



Panel Molds

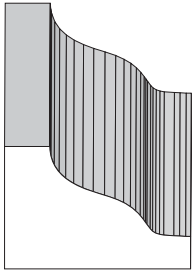

BA 686
5/8" x 1"

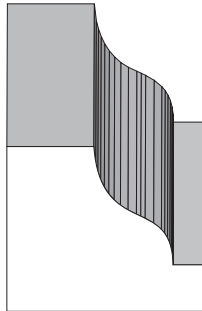

BA 1030
13/16" x 1"

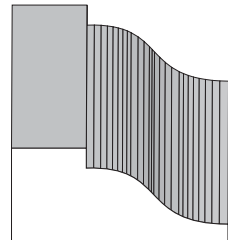

BA 303
1/2" x 1-1/8"

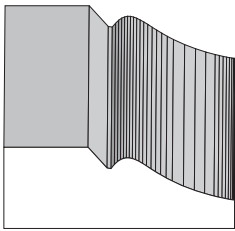

BA 190
7/16" x 1-3/16"

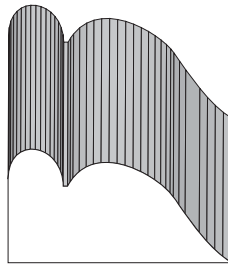

BA 539
9/16" x 1-1/8"

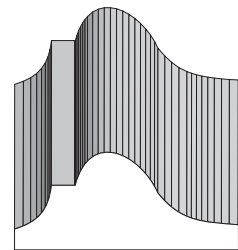

BA 289
1/2" x 1-3/16"

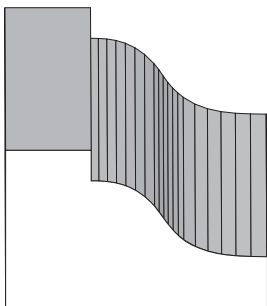

BA 1029
3/4" x 1-5/16"

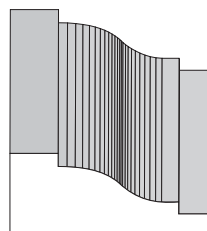

BA 1129
7/16" x 1-1/16"

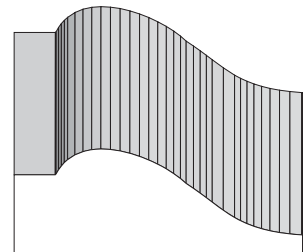

BA 169
1/2" x 1-7/16"

Profile dimensions can be adjusted, please call for details.



Panel Molds

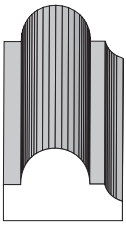

BA 1164
3/8" x 5/8"

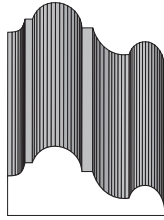

BA 1275
3/8" x 13/16"
Similar to BA 558

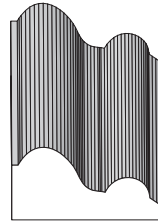

BA 1168
3/8" x 13/16"

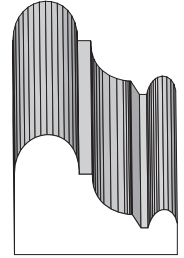

BA 18
5/8" x 7/8"

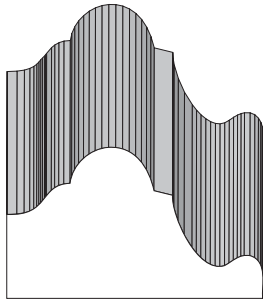

BA 512
3/4" x 1-5/16"

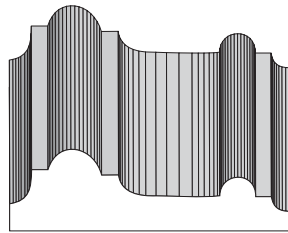

BA 1183
7/16" x 1-1/2"

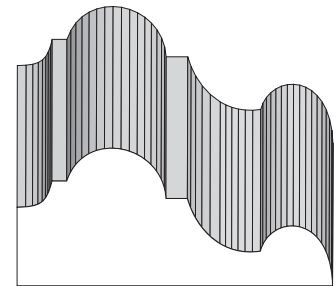

BA 558
11/16" x 1-5/8"

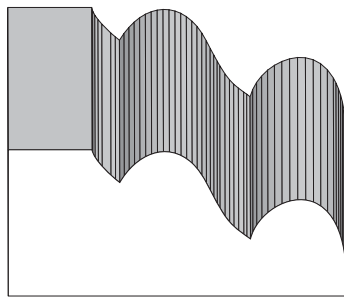

BA 1191
3/4" x 1-3/4"

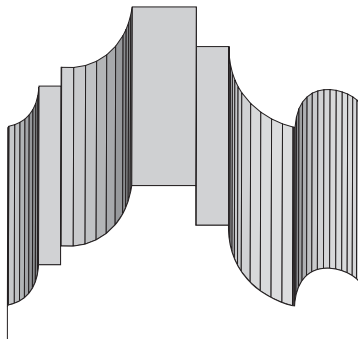

BA 78
3/4" x 1-13/16"

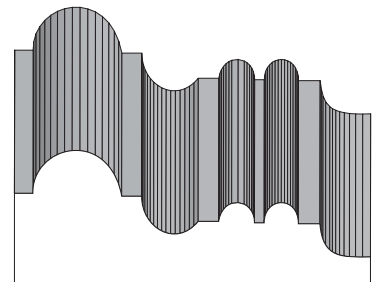

BA 1207
11/16" x 1-7/8"

Profile dimensions can be adjusted, please call for details.



Panel Molds



BA 674
5/8" x 1-5/8"

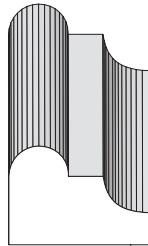

BA 39
1/2" x 3/4"

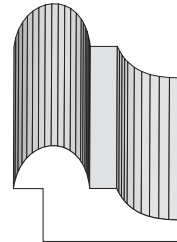

BA 878
1/2" x 7/8"

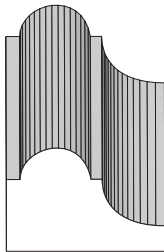

BA 519
1/2" x 13/16"

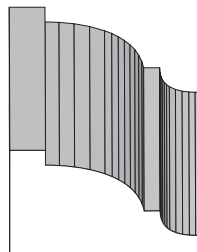

BA 531
9/16" x 1"

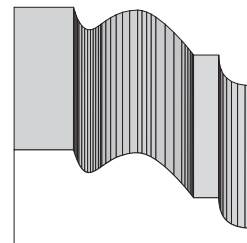

BA 1090
1/2" x 1-1/4"

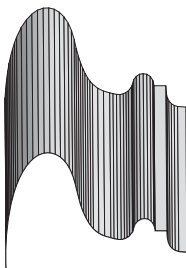

BA 591
5/8" x 1"

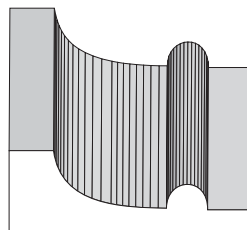

BA 1099
7/16" X 1-1/4"

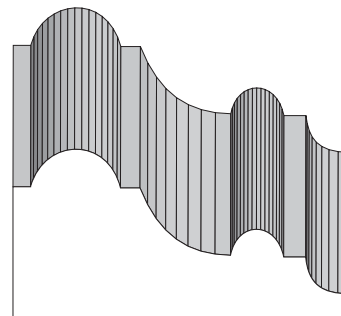

BA 1052
7/8" x 1-3/4"

Profile dimensions can be adjusted, please call for details.



Panel Molds

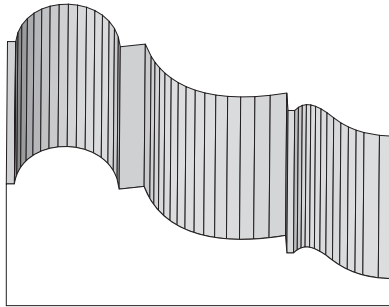

BA 843
13/16" x 2"

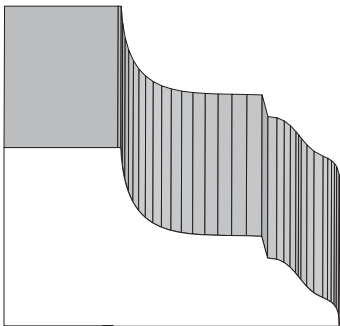

865
15/16" x 1-3/4"

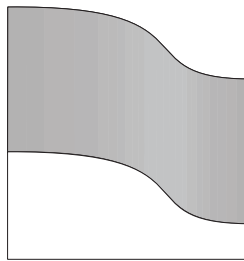

BA 1448
9/16" x 1-1/4"

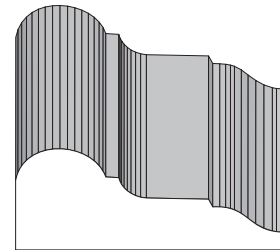

BA 571
1/2" x 1-3/8"

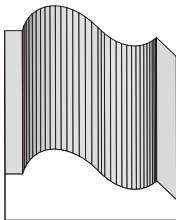

BA 828
3/8" x 7/8"

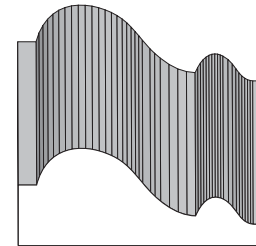

BA 902
1/2" x 1-1/4"

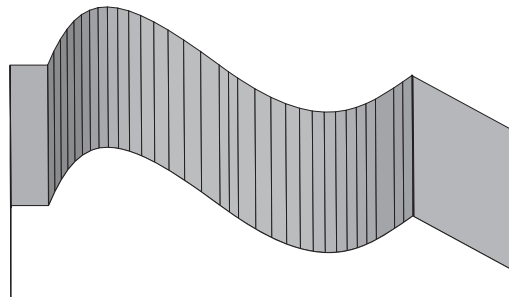

BA 34
3/4" x 2-3/4"

Profile dimensions can be adjusted, please call for details.



Panel Molds

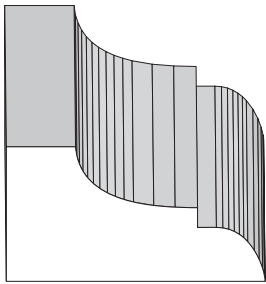

863
11/16" x 1-3/8"

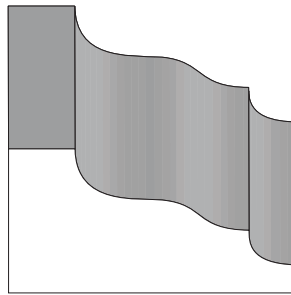

BA 1550
3/4" x 1-1/2"

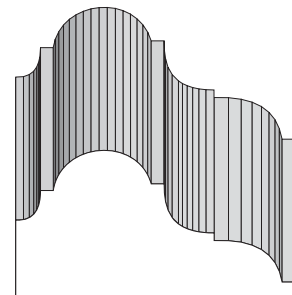

BA 449
3/4" x 1-1/2"

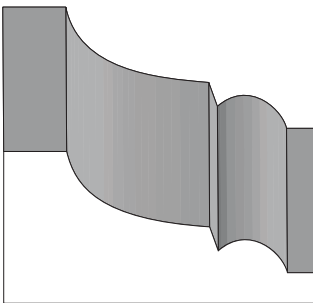

BA 1507
11/16" x 1-5/8"

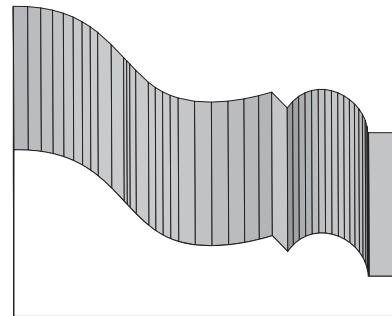

BA 887
7/8" x 2"

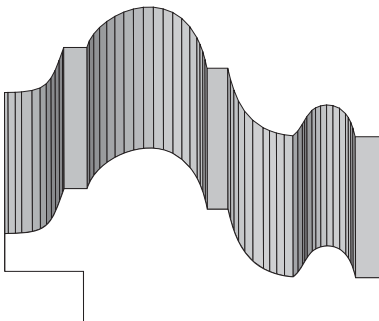

BA 960
7/8" x 2"

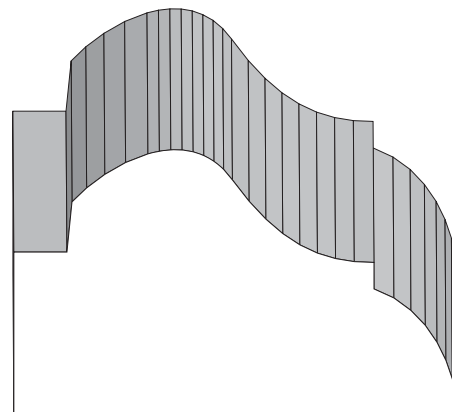

BA 694
1-3/8" x 2-5/16"

Profile dimensions can be adjusted, please call for details.



Panel Molds

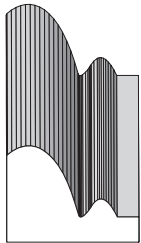

BA 322
1/2" x 11/16"

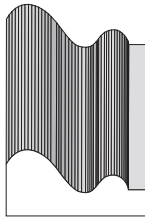

BA 445
3/8 x 3/4"

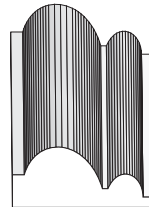

BA 593
5/16" x 3/4"

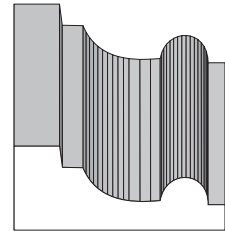

BA 541
7/16" x 1-1/8"

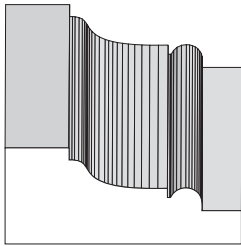

BA 422
1/2" x 1-1/4"

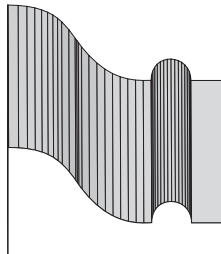

BA 447
9/16" x 1-1/8"

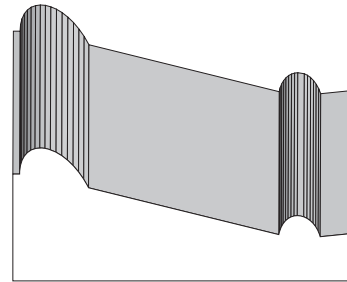

BA 814
11/16" x 1-3/4"

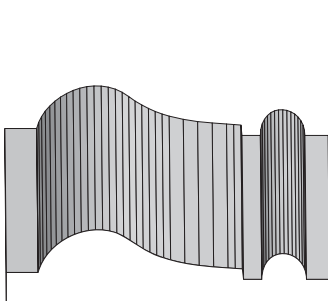

BA 467
3/8" x 1-11/16"

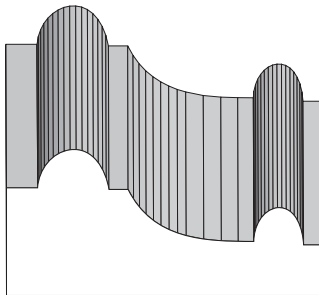

BA 678
3/4" x 1-11/16"

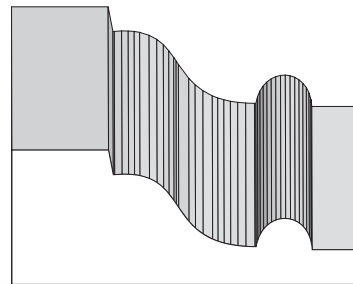

BA 246
11/16" x 1-13/16"

Profile dimensions can be adjusted, please call for details.



Panel Molds

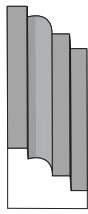

BA 1372
5/16" x 7/16"

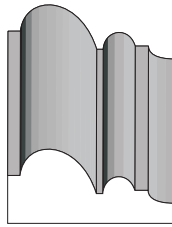

BA 1465
3/8" x 7/8"

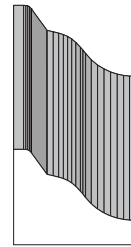

BA 1277
1/2" x 5/8"

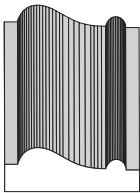

BA 1126
1/4" x 3/4"

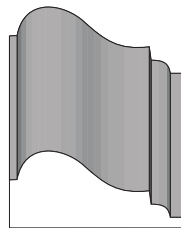

BA 1364
7/16" x 15/16"

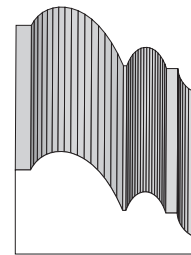

BA 1114
1/2" x 7/8"

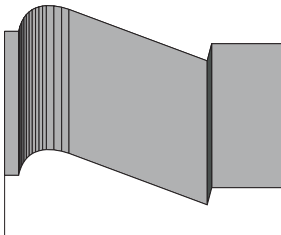

BA 1285
7/16" x 1-7/16"

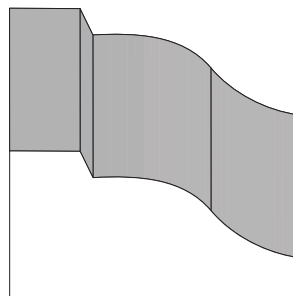

BA 1393
3/4" x 1-1/2"

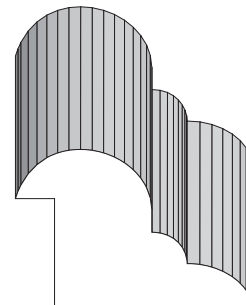

BA 1235
13/16" x 1-1/4"

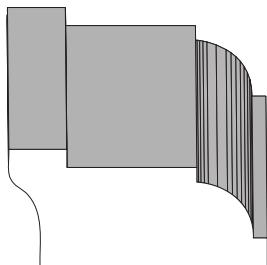

BA 1226
5/8" x 1-3/8"

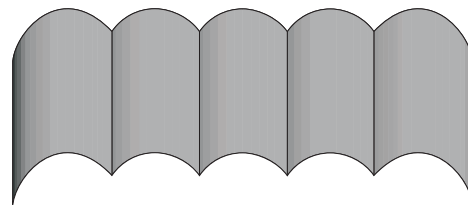

BA 1361
1/4" x 2-3/8"

Profile dimensions can be adjusted, please call for details.



Panel Molds

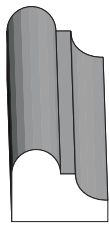

F6111

BA 1619
3/8" x 1/2"

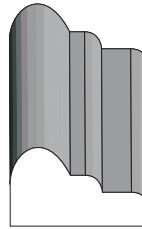

BA 1568
7/16" x 11/16"

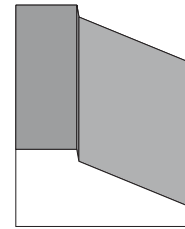

BA 1577
3/8" x 15/16"

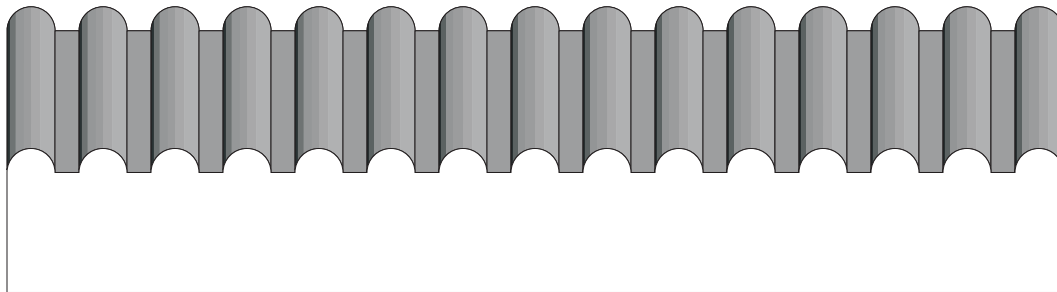

BA 1656
3/4" x 5-1/2"

Profile dimensions can be adjusted, please call for details.